

Output Wiring Onboard 24VAC Humidifier with Contactor

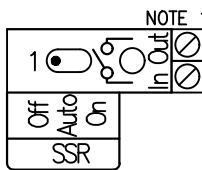

NOTE 1

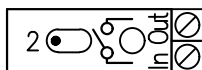
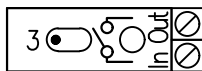
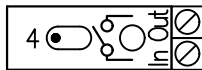
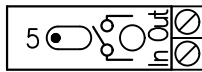
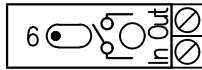
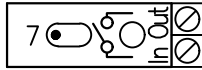
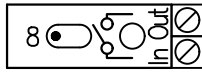
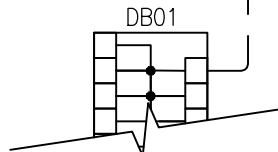

GREY 19 CONNECTION 24VAC DISTRIBUTION BLOCK (NEUTRAL) LOCATED ON DIN RAIL IN CONNECT CONTROLLER ENCLOSURE

IMPORTANT WARNING

Ensure Relay/Contactor used is rated for the voltage and current draw required for the humidifier. Consult the humidifier manual for external control options. Actual wiring may vary based on make and model used.

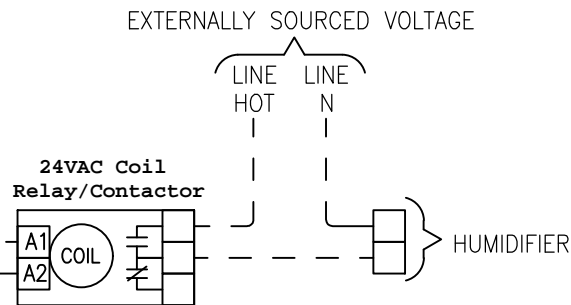

NOTES:

1. ENSURE BLUE JUMPER IS INSTALLED.